

CLE-PEN Cleaner M16 Instruction Manual

Thank you for choosing the CLE-PEN Cleaner M16. The CLE-PEN Cleaner M16 is a high-performance device designed for cleaning the ferrule end faces of 1.6mm harsh environment connectors. Please carefully read this instruction manual before using this device. Please keep this instruction manual for future reference.

1. Safety precautions

	Though our device is deemed safe, improper usage or handling can still inflict injury to others.
	CLE-PEN Cleaner M16 is designed to clean 1.6mm based connectors only. We are not liable for damage caused in attempt to apply this device to other applications.

2. Notes on usage





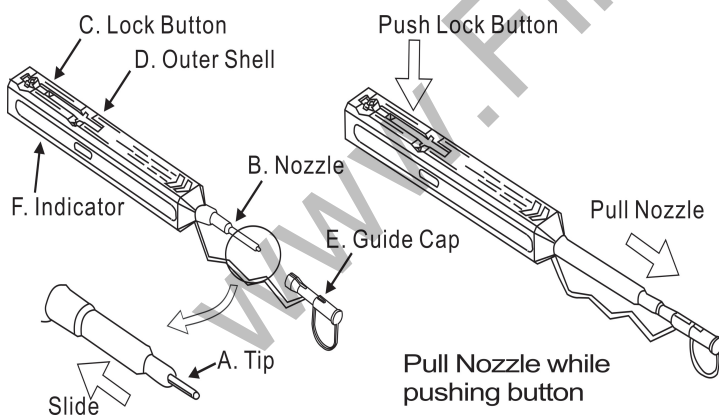

- Do not attempt to disassemble as this can cause damage to the device and void warranty.
- Do not re-use cleaning cloth as this will eliminate its cleaning ability.
- Do not touch the cleaning cloth as this will cause contamination.
- Do not pull the cleaning cloth, use only the device body.
- Do not use this cleaner when the cloth is empty, as this can cause damage to the connector.

3. Notes on storage for extended periods

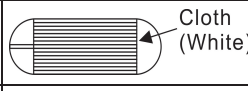
- Do not expose device to direct sunlight, high temperature or high humidity.
- The cover on the guide cap should be closed at all times when device is not in use.

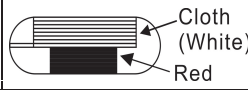
4. Device construction



	View of Indicator	View of the Nozzle end
Full	 Cloth (White)	 Tip (Black) String (White)
Little	 Cloth (White) Red	 Tip (Black) String (White) Slide
Empty	 Red	 Tip (Black) No String (Black) Slide

Standard Mode

Extended Mode

Identification of remaining cloth

NO	Part Name	Function
A	Tip	Lead the cleaning cloth to the optical connector end face
B	Nozzle	Lead tip to the optical connector end face.
C	Lock Button	Push the button to extend and contract the nozzle
D	Outer Shell	Push the outer shell to clean the connector.
E	Guide Cap	Acts as dust cap or cleaning adapter for connector plug.
F	Indicator	Provides indication of remaining cleaning cloth

5.Applications

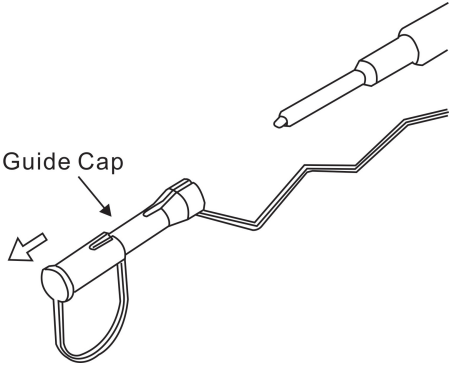
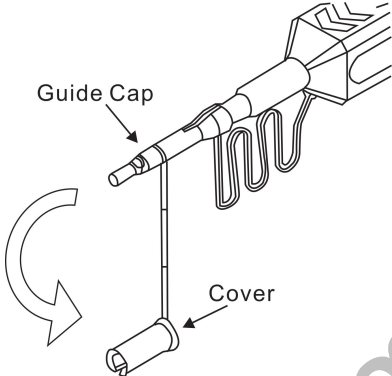
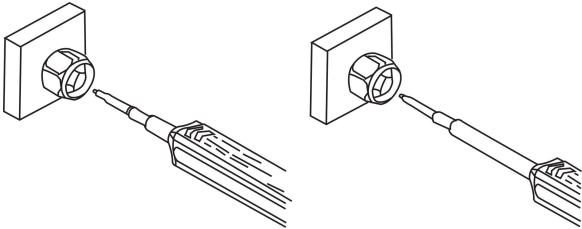
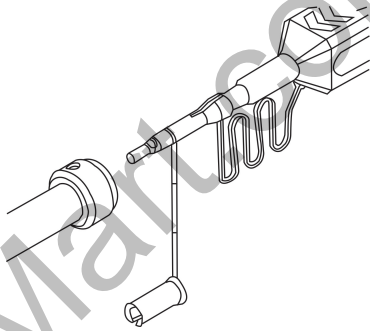
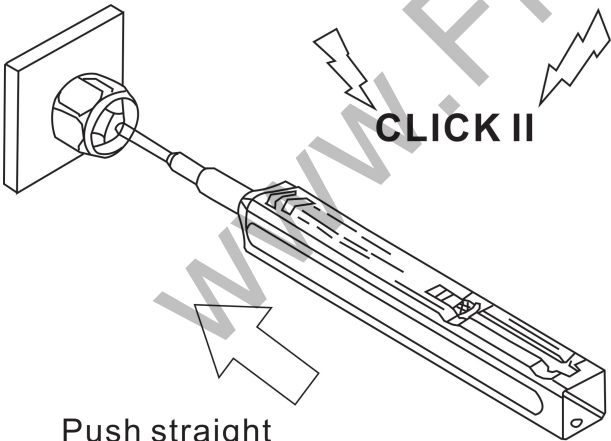
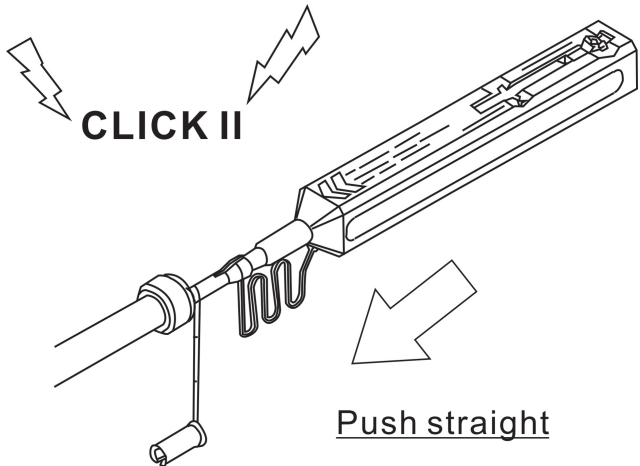
<p><Connector inside adapter> 1.Remove Guide Cap from the device.</p> 	<p><Connector plugs alone> 1. Open the Cover on the Guide Cap.</p> 
<p>2.Insert tip of cleaner into the connector.</p>  <p style="text-align: center;"><u>Standard Mode</u> <u>Extended Mode</u></p>	<p>2. Insert guide cap onto the ferrule.</p> 
<p>3.Push the Outer Shell to initiate the cleaning the 1.6mm ferrule end face. An audible “click” sound indicates end of cleaning process. Close the cover after use.</p>  <p style="text-align: center;"><u>Push straight</u></p> <p>Do not overly exert force during insertion as this may cause damage to both the connector and the CLE-PEN Cleaner M16.</p> <p>If pushing Outer Shell is inhibited, remove CLE-PEN Cleaner M16 and verify there is no sizable debris is inhibiting the cleaning process.</p>	<p>3.Push the Outer Shell to initiate the cleaning the 1.6mm ferrule end face. An audible “click” sound indicates end of cleaning process. Close the cover after use.</p>  <p style="text-align: center;"><u>Push straight</u></p> <p>Do not overly exert force during insertion as this may cause damage to both the connector and the CLE-PEN Cleaner M16.</p> <p>If pushing Outer Shell is inhibited, remove the CLE-PEN Cleaner M16 and verify there is no sizable debris is inhibiting the cleaning process.</p>